



GIRA

When your
home is your
comfort zone.

Gira / Flexible building technology

We are Gira.
We are the ones with the switches.
But we're so much more.

Future-oriented.
Certified.
Responsible.

We're the guardians, innovators,
smart home pioneers, developers,
systems thinkers, KNX partners,
shapers of the future, patent masters,
award winners and designers.

But above all, we're the ones
who listen.
To you.

Subtle, but smart.
With distinct focus on quality,
materials and functions.
And the driving force of innovation.

In our hearts, we are engineers
on a mission to inspire.
With new technologies,
smart applications, and
impressive attention to detail.

We will always work our hardest
to find the best solution for you.
With service, design and performance
made in Germany.

Because that is what we stand for.
And have been standing for since 1905.

02	_____	Introduction
04	_____	Gira System 3000
06	_____	Bluetooth and RF
08	_____	Gira System 3000 expansion levels
14	_____	Gira System 55
16	_____	Security and door intercom systems
18	_____	Service
20	_____	Company

Intelligent planning. Making wishes come true.

Having your own home is often more than just a construction project. It's a lifelong dream and an expression of individuality, freedom and security. With a house, you are laying the foundations for the future. Everything must be right – down to the last detail. With building technology that is convertible and adapts to your wishes and possibilities. Gira will accompany you – from the conventional solution to the intelligent Smart Home.



Flexible building technology / Gira System 3000



Smart Home solutions as flexible as life itself.

Inserts: the basis for your Smart Home

With the Gira System 3000, you are laying the functional foundations for lighting control, shading with blinds or similar, and room temperature control*. The ideal preparation for your future Smart Home.

Thanks to the inserts' extra-flat design, they are quick and easy to install in any

standard flush-mounted box based on the existing conventional wiring.

Various inserts and top units are available for controlling the light and room temperature, as well as awnings, shutters and blinds. Their modular design means that they can provide a solution for virtually every building technology function.

Gira System 3000 components

- 01 Flush-mounted box
- 02 Gira System 3000 control insert
- 03 Gira E2 design line
- 04 Gira System 3000 operating top unit

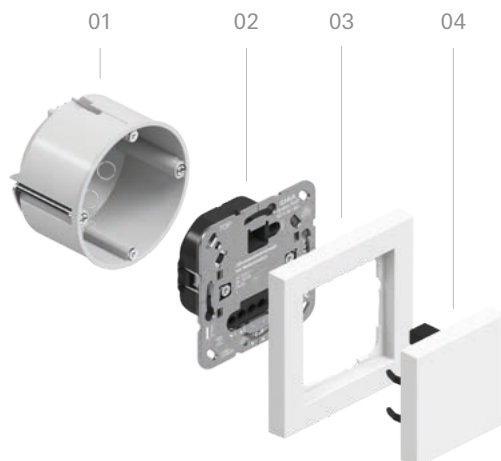

05

06



Operating elements

- 05 Gira System 3000 operating top unit
- 06 Gira System 3000 blind timer and timer Display

Top units: the choice is yours

Start with the Gira System 3000 operating top unit, which you can use to directly operate the function connected to the insert. You can always opt for top units that offer more convenience at a later stage, such as the Gira System 3000 blind timer and timer Display.

Whenever it suits your plans or budget, with complete flexibility re timing and spatial requirements. And with no new wiring or mess. No matter which operating top unit you pick, the devices themselves are powered via the insert and do not require any additional batteries.

Live comfortably – by design.

Looking for more convenience?
And more options? The solution is
simple. Just change the top unit.

Switch to the Gira System 3000 Bluetooth top unit, for example. This is easier than you think, because nothing needs to be changed on the insert or the walls. With Bluetooth and the Gira System 3000 Bluetooth App, you can set your

light source in a variety of ways so that it always switches itself on and off at fixed times. And dims. Or you can set your blind to only move down to a certain position. Or automatically reduce your room temperature at night.

Many options – and all completely intuitive. Your smartphone or tablet provides a clear overview of all the top unit's settings. And you can even control them from your sofa. No server or network is needed.

01



02



03



Operating elements

- 01 Gira System 3000 blind timer and timer BT
- 02 Gira System 3000 room temperature controller*
- 03 Gira System 3000 Bluetooth App

Even smarter. Control your home from any room.

01



02



Components

- 01 Gira eNet wireless operating top unit Memory
- 02 Gira eNet server



Convenience is the most pleasant form of freedom. Free to enjoy all the comforts of upscale living with just the touch of a finger. Take your first Smart Home steps with the eNet wireless operating top unit Memory. Convenient wireless control is also possible from other rooms, for example from your basement or garden.

You can also control entire light or room scenes or several blinds simultaneously from a central point.

If you then also establish a wireless connection between the top unit and your Gira eNet server, you will have additional options, and can even control your building technology from a smartphone or tablet while on the move, using the Gira eNet SMART HOME App.

Or by voice control using Amazon Alexa and Google Assistant. Smart devices from other eNet alliance manufacturers can also be integrated into the system.

There are many ways to your Smart Home. You decide.

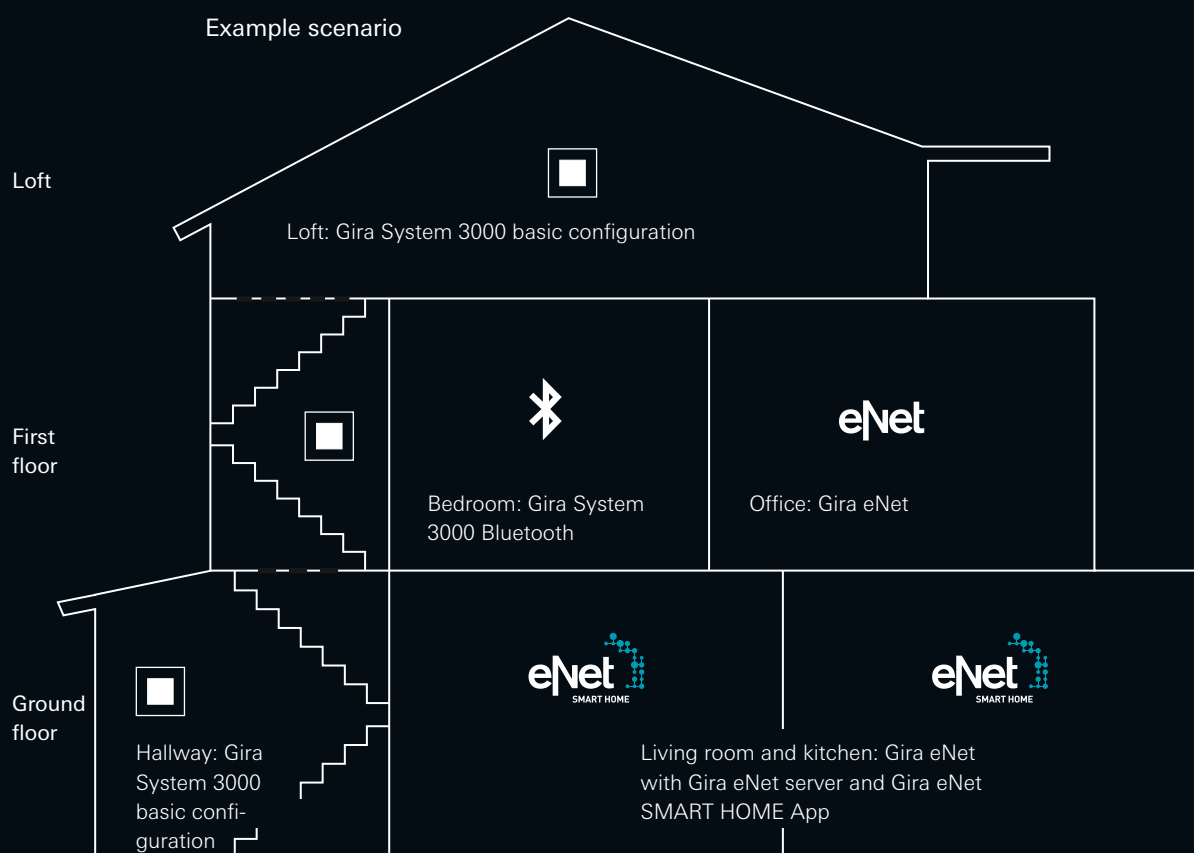

**A Smart Home is achievable.
At any time. In any room.**

If at some point you want more than just switching lights on and off, discover the many options available to you for convenient and intelligent building technology. All over the house. In individual rooms. Or even just for individual functions. Whenever it suits you. Either way, with the Gira System 3000 you are "Smart Home ready".

**No rewiring.
No mess.**

No matter which solution you opt for, the top units are replaced without any rewiring or the expensive and complex conversion work that comes with this. You can extend the control of your building technology in no time at all, simply by switching the top units.

As flexible as you are.

It's nice not to have to go all out straight away. The Gira System 3000 enables the flexible exchange and combination of individual top units. In a room, you can

have the lighting operated with a conventional switching top unit and the shading via Bluetooth or eNet. If you prefer it the other way round? Just switch.

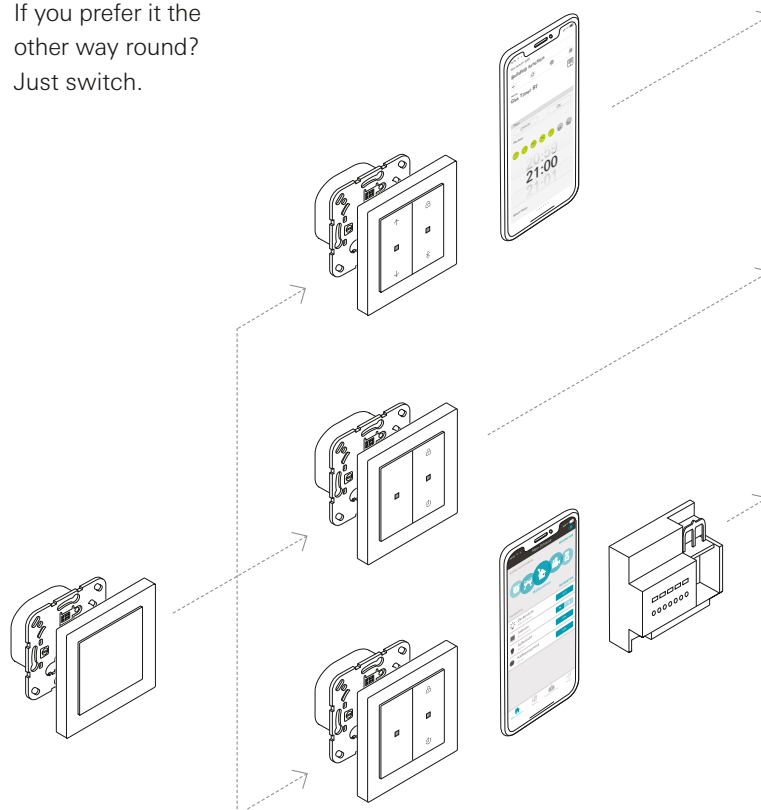

Gira System 3000 basic configuration

- Flush-mounted insert: Gira System 3000
- Top unit: Gira 3000 operating top unit

Bluetooth control

- Flush-mounted insert: Gira System 3000
- Top unit: Gira System 3000 blind timer and timer BT
- App-based operation: Gira System 3000 Bluetooth App

Wireless control via eNet

- Flush-mounted insert: Gira System 3000
- Top unit: Gira eNet wireless operating top unit Memory

Gira eNet SMART HOME

- Flush-mounted insert: Gira System 3000
- Top unit: Gira eNet wireless operating top unit Memory
- App-based operation: Gira eNet SMART HOME App
- Control unit: Gira eNet server

⊕ Gira System 3000 – highlights, facts and benefits:

- Functions can be extended piece by piece.
- Flexible implementation exactly how you want it, at a time that suits you – and your pocket.
- Simply switch the top units. No specialist prior knowledge required.
- Functions extended without any new wiring.
- Not battery operated; the top units are supplied with power via the insert.

Flexible building technology / Gira System 55



One system with numerous options.

Gira System 3000 basic configuration

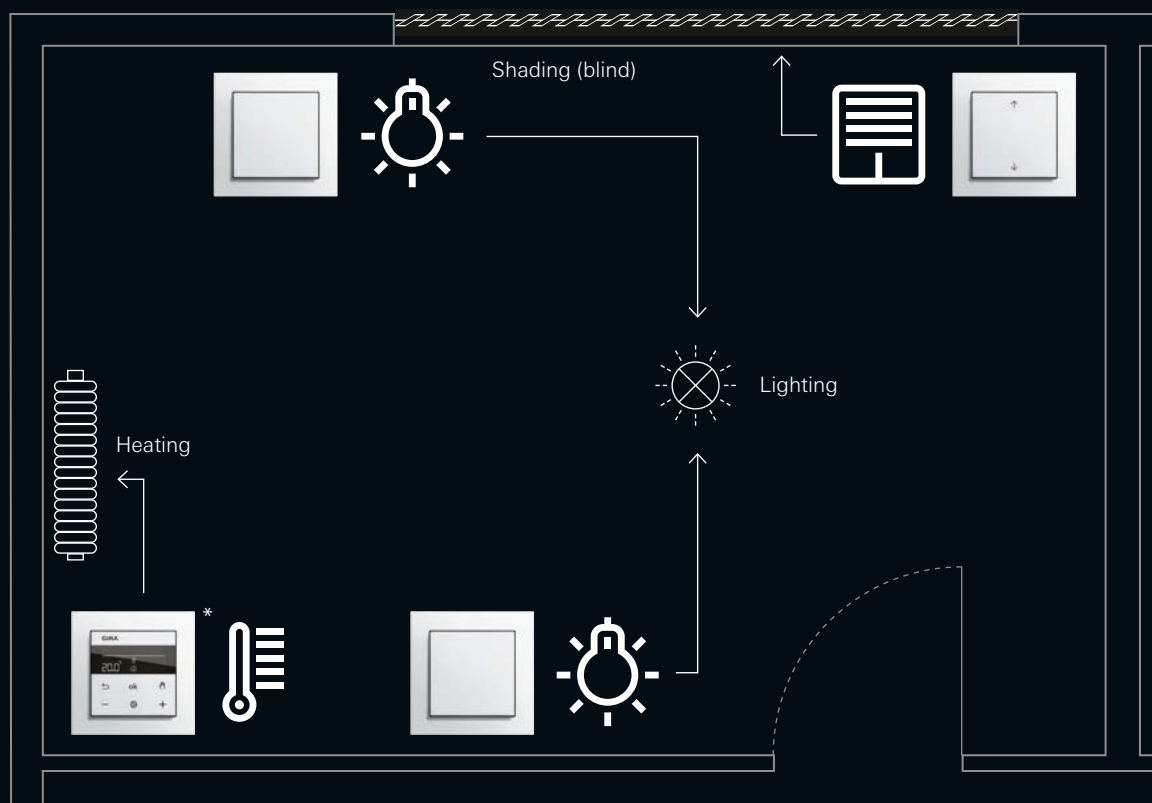

The reliable basis for manually operating lights, blinds and room temperature control with initial convenience functions.



Gira System 3000 – highlights, facts and benefits:

Easy to install, immediately ready for operation.

Automatic switch-off for lights can be activated without additional devices, for staircases, hallways, etc.

The blind insert stores an individual setting (shading or ventilation position).

Gira System 3000 Bluetooth

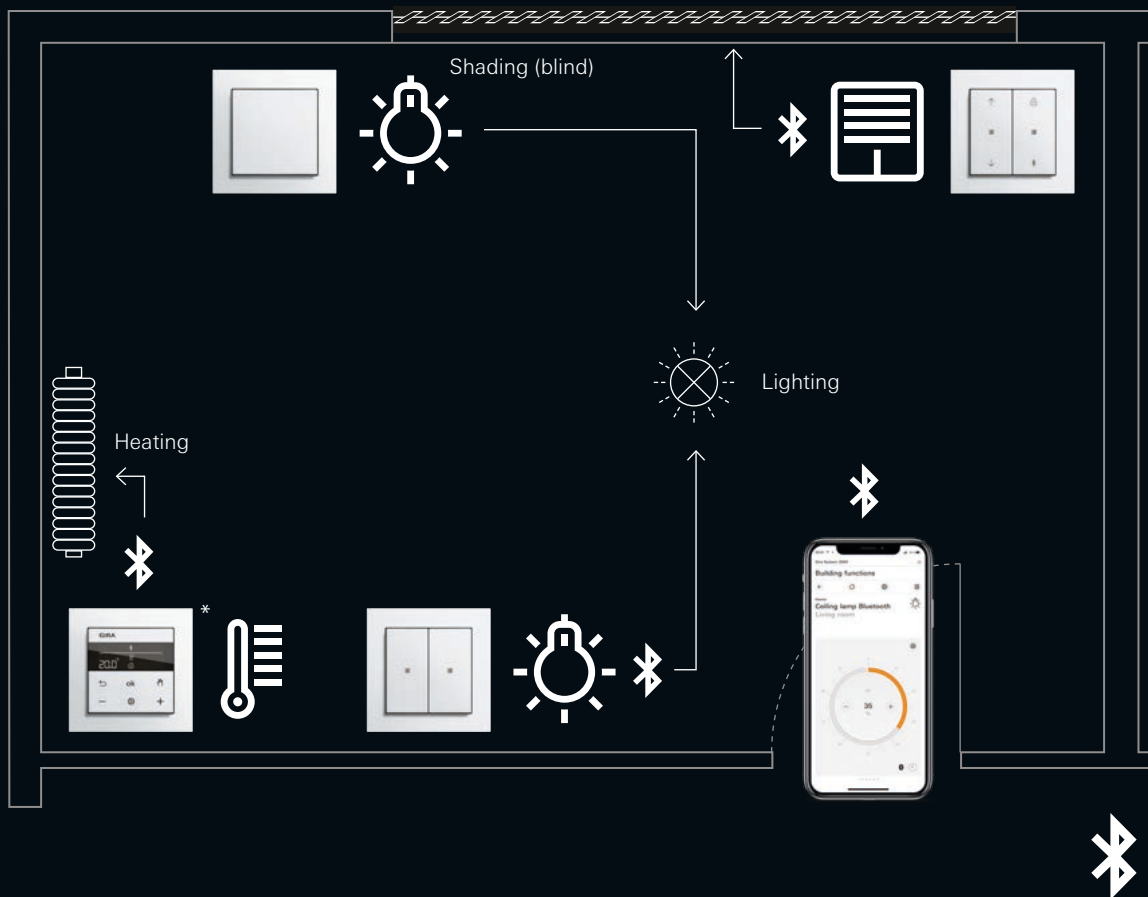

Bluetooth for added convenience. Set and control shading, lighting and temperature easily and as required using the Gira System 3000 Bluetooth App – with everything clearly in view and under control.



Gira System 3000 Bluetooth – highlights, facts and benefits:

The operating top unit can be easily exchanged with no specialist knowledge.

No mess, no new wiring.

Can also be implemented as an isolated solution for a single function.

Operated using Gira System 3000 Bluetooth App.

Gira System 3000 eNet

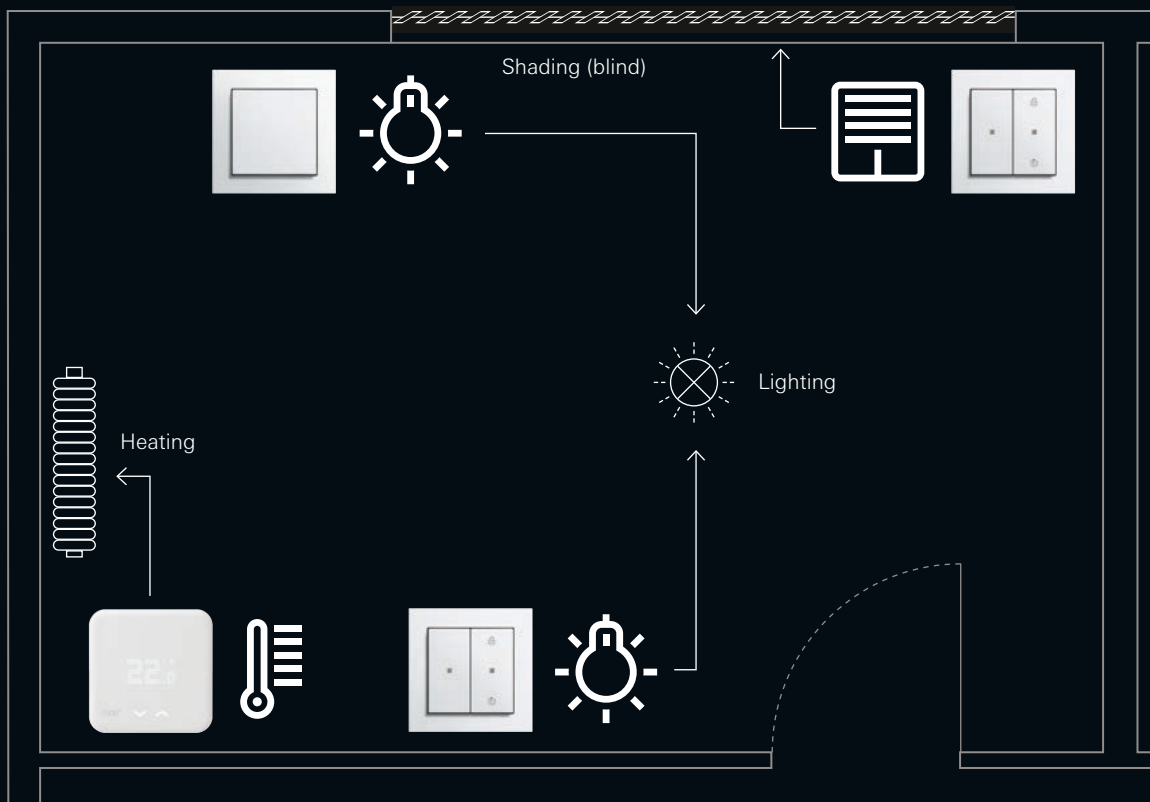

eNet

eNet is the future-proof wireless system for intelligently networking and controlling your Smart Home's building technology.

⊕ Gira System 3000 eNet – highlights, facts and benefits:

The operating top unit can be easily exchanged with no specialist knowledge.

No mess, no new wiring.

Networked control of several devices (group commands e.g. scene control).

High range.

Can also be implemented as an isolated solution for a single function.

Functional extension to include mobile operation, for example, using the Gira eNet hand-held transmitter.

Gira System 3000 eNet with Gira eNet server

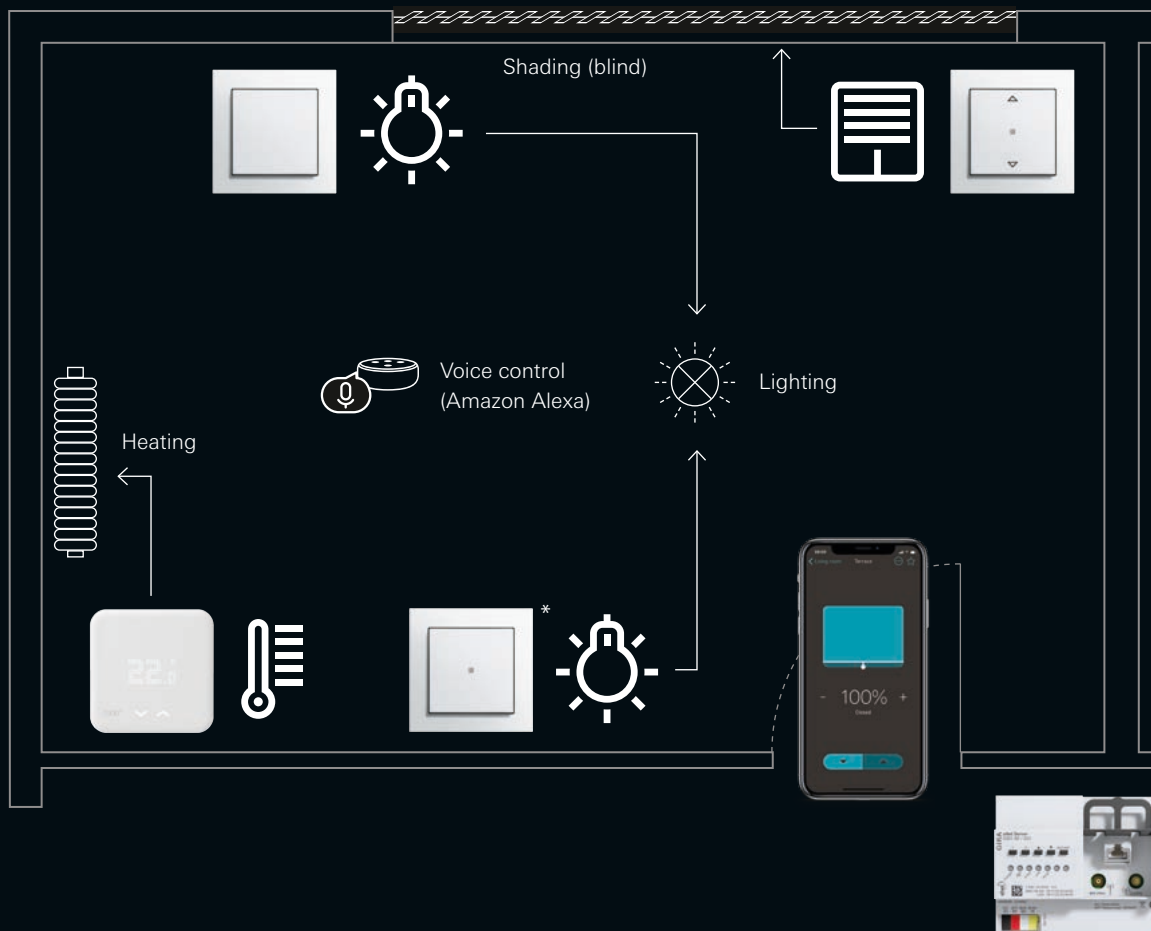

With eNet SMART HOME, you can easily control and monitor your building technology using the app – even when on the go. All thanks to the Gira eNet server: the control centre of the eNet wireless system.

+ Gira System 3000 with Gira eNet server – highlights, facts and benefits:

Can also be networked with devices from other manufacturers (eNet alliance with Brumberg, Häfele, tado°, Steinel).

Energy consumption indication on the Gira eNet SMART HOME App.

Voice control for Amazon Alexa / Google Assistant.

Data security due to encrypted wireless transmission.

eNet server



Many functions, one system.

Everything from a single source.
It's nice when you can trust a brand.
Now and in the future.

Gira offers everything that modern building technology needs. First-class design. Sophisticated, functional and sustainable products – made in Germany. Take the Gira System 55, for example.

An ingenious modular system providing more than 300 functional inserts, from socket outlets and switches to the Gira radio. Thanks to the standard format, the frames can be easily exchanged. Discover your favourites from 11 design lines with over 90 frame variants.

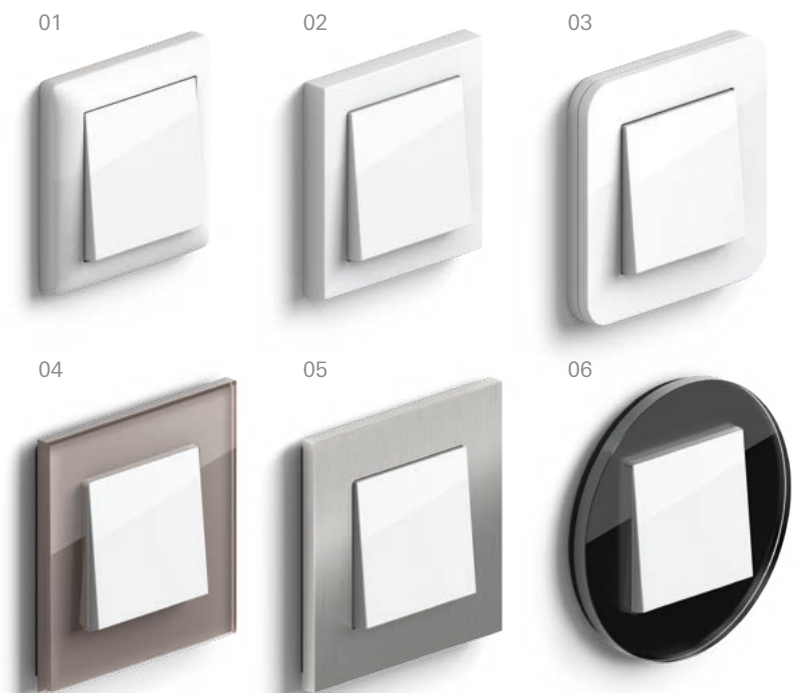

Selection of design lines

- | | |
|---------------------------------------|--------------------------------|
| 01 Gira Standard 55 pure white glossy | 04 Gira Esprit umber glass |
| 02 Gira E2 pure white glossy | 05 Gira Esprit stainless steel |
| 03 Gira E3 pure white glossy | 06 Gira Studio black glass |

Playing it safe. In style.

You should not compromise on your sense of well-being, freedom or security. The same goes for the design.

01



02



03



Set the tone from the start: at your front door. Welcome your visitors with excellent design and reliable technology. Like so much from Gira, the Gira System 106 door station with individually

combinable modules adapts to your wishes. Speak, hear and see.

Inside, the Gira surface-mounted video home station provides a complete overview. Just to name two examples.

Install Gira and relax. With many practical security functions such as the alarm system, smoke alarm device, motion detectors and much more, you and your home are fully protected. Exactly according to your requirements.

- 01 Gira System 106 stainless steel door station
- 02 Gira surface-mounted video home station 7
- 03 Gira Dual Q smoke alarm device



The focus of all of our efforts? You.

Innovator. System finder. Future shaper. Gira develops products that lead the way in technology and design. We make rooms think; we give technology a heartbeat; we take responsibility for the future and shape it. Our benchmark for this? The individual requirements of our customers. That means you.

Design Configurator

Using the Gira Design Configurator, you can combine all Gira design lines with functions of your choice. The personally configured product can then be viewed and saved live within your own four walls. Give it a try at: designconfigurator.gira.com

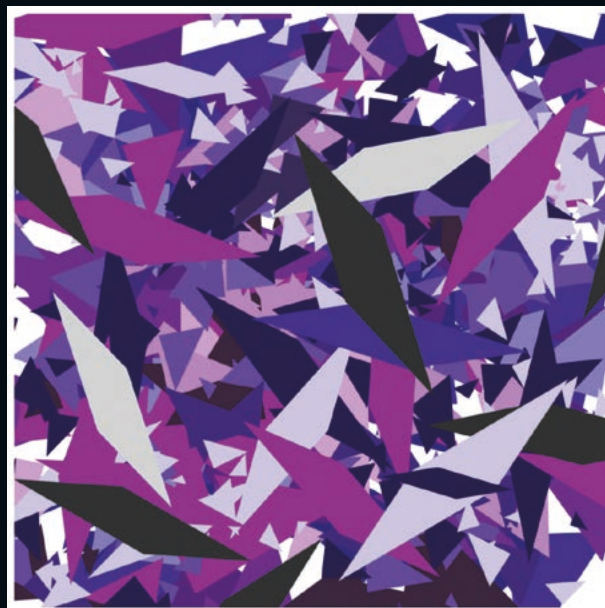

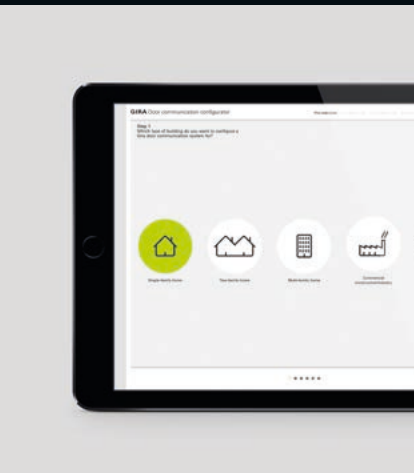

DCS Configurator

With the user-friendly Gira door communication configurator, finding the right system components for your future door intercom system is as easy as ABC. Simply go to: dcsconfigurator.gira.com

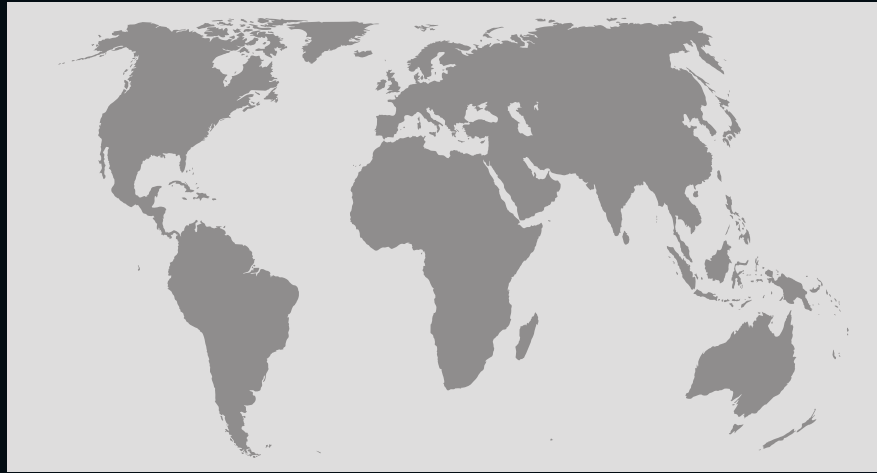

G-Pulse

The interactive design magazine from Gira provides ideas and inspiration for current topics in home design, smart technology, architecture, light and lifestyle: g-pulse.com

Social media

Follow the Gira Community:



System integrators and KNX experts

For comprehensive system consulting or for assistance with building automation, we offer support from system integrators and KNX experts. More information at: gira.com/systemintegrators

Contacts

You can find contacts in your region at: gira.com/country

Inscription service

The Gira inscription service provides neat, uniform inscriptions for your doorbell inscription labels or pushbutton sensors, for example. Laser inscriptions are supplied via your electrical engineering firm. Simply order online at: marking.gira.com



Showrooms

Where our brand comes to life: You can view, touch and try out our products in a large number of Gira showrooms: gira.com/showrooms

Being innovative means thinking beyond your own four walls.

Gira is a family-run company, and has been for four generations. It's what keeps us at the forefront of residential technology, revolutionising the market with innovative products and system solutions.



"Made by Diversity"

Gira has been producing products at its location in Radevormwald for more than 100 years. The company is fully committed to the "Made in Germany" quality standard. This is what 1,250 employees from 27 nations work for – each and every one of them with different talents, individual expertise, wide-ranging experiences and different life stories. This diversity – supported by common values – is the basis for our creativity, innovative strength and viability for the future.

Innovative technology meets excellent design

Gira has always aspired to combine maximum functionality and reliability in a unique design. With a host of international design awards to their name, our stylish product lines set new standards in development and innovation.

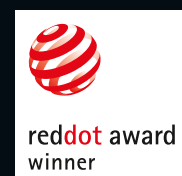

Published by:
Gira Giersiepen GmbH & Co. KG

Picture credits:
Pag. 07
Tillmann Frantzen
Pag. 14-15
Interfacedesign:
Pag. 06, 11
schmitz Visuelle Kommunikation
hgschmitz.de

Subject to technical modifications.

Any colour variations between the images in this product information and the product are due to printing processes and cannot be avoided.

Shaping the future also means doing everything possible to protect the environment in which we want to live in the future. Gira supports the idea of sustainability by handling resources responsibly and using environmentally friendly materials in this brochure. The paper types processed are FSC®-certified and consist of at least 60% waste paper.

www.sustainability.gira.com



GIRA

—
Gira
Giersiepen GmbH & Co. KG
Electrical installation
systems

Industriegebiet Mermbach
Dahlienstraße
42477 Radevormwald

P.O. Box 12 20
42461 Radevormwald
Germany

Phone +49 2195 602-0
Fax +49 2195 602-119

www.gira.com
info@gira.com

Order no. 18129 90 07/20 x. 22